



Truck Refrigeration

TRANSICOLD

United Technologies



**Operator's Manual
for
20X and 35X
Road Only
Truck Refrigeration Units
with Cab Command Controller**



**Operator's Manual
for
20X and 35X
Road Only
Truck Refrigeration Units
with Cab Command Controller**

Table of Contents

Introduction	1
Safety	2
Unit Identification	3
Keypad and Display	5
Unit Operation	6
Operating Principle.....	6
Starting	7
Temperature Setpoint	8
Manual Defrost	9
Defrost Interval	10
Minimum Setpoint, Out-of-Range, and Continuous Airflow	11
Stopping the Unit	12
Product Loading	13
Before Loading	13
During Loading	13
Recommended Transport Temperatures	15
Problems and Alarms	16
Alarm Display	17
Alarm List	18
Alarm Reset	19
Fuses	20
Unit Maintenance	21
Service Schedule	22
Emergency Road Service	23
Index	24

Introduction

This guide has been prepared for the operator of Carrier Transicold 20X and 35X Road Only Truck Refrigeration units with Cab Command Controller. It contains basic instructions for the daily operation of the refrigeration unit as well as safety information, and other information that will help you to deliver the load in the best possible condition. Please take the time to read the information contained in this booklet and refer to it whenever you have a question about the operation of your Carrier Transicold truck refrigeration unit.

Your refrigeration unit has been engineered to provide long, trouble-free performance when it is properly operated and maintained. A comprehensive maintenance program will help to insure that the unit continues to operate reliably. Such a maintenance program will also help to control operating costs, increase the unit's working life, and improve performance.

This guide is intended as an introduction to your unit and to provide general assistance when needed. More comprehensive information can be found in the Operation and Service Manual for your unit. This manual can be obtained from your Carrier Transicold dealer.

When having your unit serviced, be sure to specify genuine Carrier Transicold replacement parts for the highest quality and best reliability.

At Carrier Transicold, we are continually working to improve the products that we build for our customers. As a result, specifications may change without notice.

Safety

Your Carrier Transicold refrigeration unit has been designed with the safety of the operator in mind. During normal operation, all moving parts are fully enclosed to help prevent injury. During all pre-trip inspections, daily inspections, and problem troubleshooting, you may be exposed to moving parts; please stay clear of all moving parts when the unit is in operation.



Beware of unannounced starting of the fans caused by the thermostat and the start/stop cycling of the unit.

Refrigerants

The refrigerant contained in the refrigeration system of your unit can cause frostbite, severe burns, or blindness when in direct contact with the skin or eyes. For this reason, and because of legislation regarding the handling of refrigerants during system service, we recommend that whenever your unit requires service of the refrigeration system you contact your nearest Carrier Transicold authorized repair facility for service.



Inspect battery cables for signs of wear, abrasion or damage at every pretrip inspection and replace if necessary. Also check battery cable routing to ensure that clamps are secure and that cables are not pinched or chafing against any components.

Unit Identification

The unit is identified by a nameplate which identifies the complete model number of the unit, the serial number, the refrigerant charge and quantity, and the date the unit was placed in service.

If a problem occurs, please refer to the information on this plate, and make a note of the model and serial number before calling for assistance. This information will be needed when you contact a technician or Carrier Transicold Service Engineer so that he or she may properly assist you.

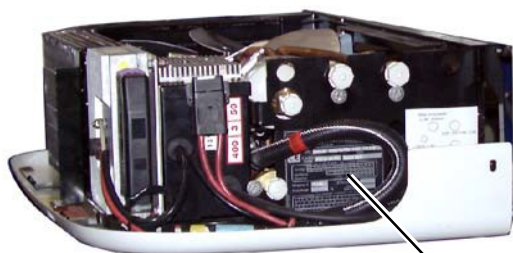

20X Nameplate

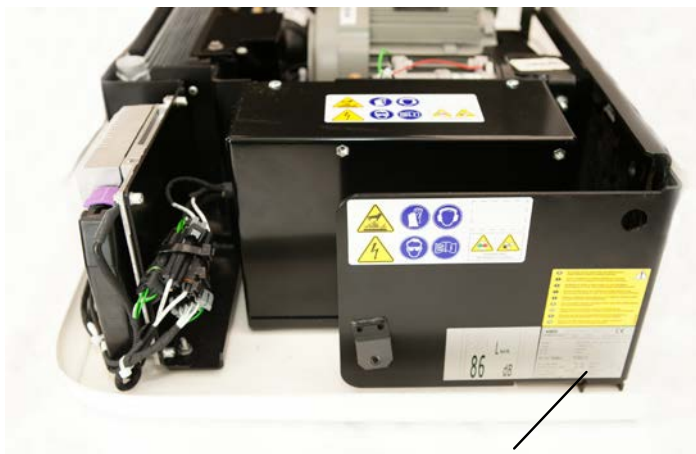

35X Nameplate







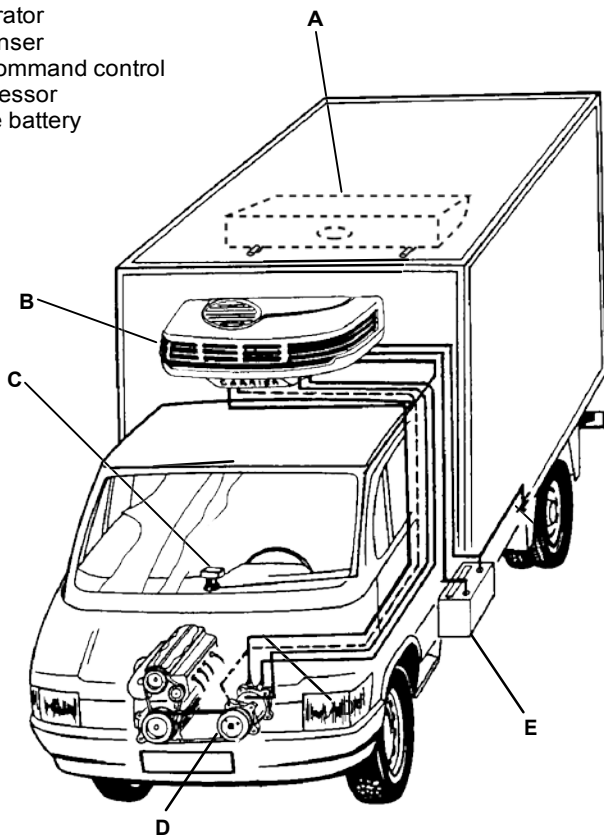



Unit Identification



- A : Evaporator
- B : Condenser
- C : Cab Command control
- D : Compressor
- E : Vehicle battery



Keypad and Display

-  Readout
-  Standby operation display (**Not Applicable**)
-  Road operation display
-  Manual defrost control key
-  Unit start-up key
-  Unit shut-down key
-  Data selection key
-  Selected data decrease key
-  Selected data increase key
-  Unit operation display
 - Green = In-range (left half)
 - Red = Alarm (right half)

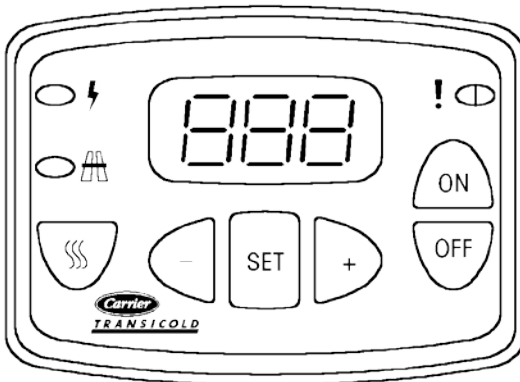

Unit Operation

Operating Principle

After starting up the refrigeration unit by pressing the **ON** key on the Cab Command, unit start-up and shutdown are automatic.

Road operation: An open-type compressor is driven by the engine of the vehicle. The vehicle battery powers the evaporator and condenser fans. The unit automatically shuts down when the engine is switched off with the ignition key.

Starting the Unit

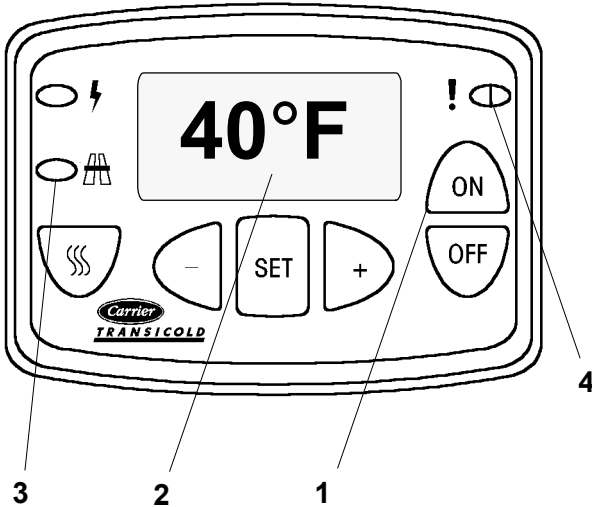

1. Press the ON key. Start-up may be time-delayed.
2. Check if box temperature is displayed.
3. Check that the road operation light is on.

NOTE: If standby power cord is plugged in, the controller will trigger a visual alarm in the form of a flashing alarm light and readout (4), and the unit will run in standby mode.

Temperature Setpoint

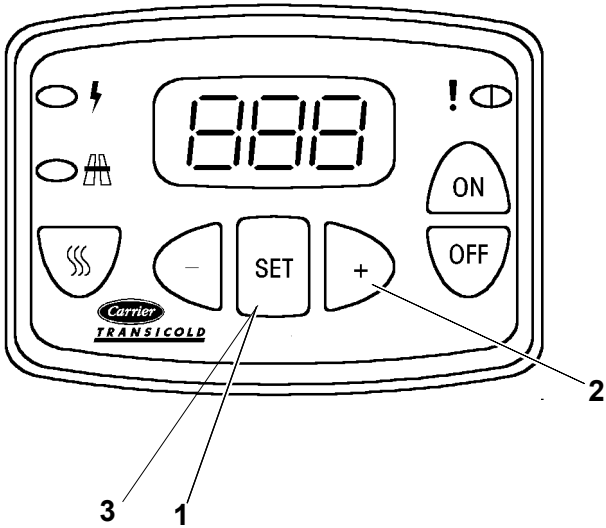

1. Press SET key to display setpoint.
2. Press + (plus) key to increase setpoint or press - (minus) key to decrease setpoint.
3. Press SET key when desired setpoint is displayed to lock in new setpoint.

Manual Defrost

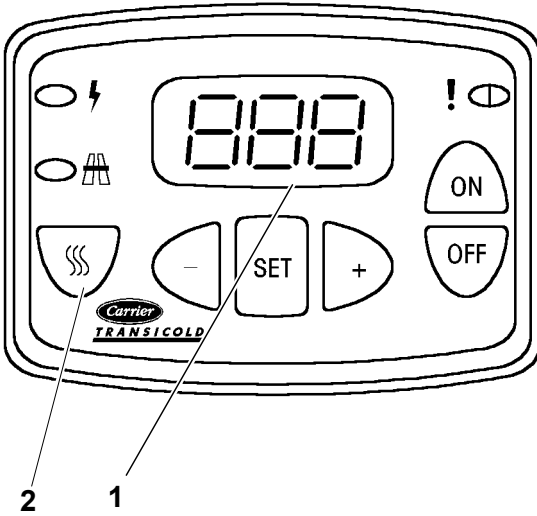

1. Check that box temperature is 40°F or lower.
2. Press Manual Defrost key to initiate manual defrost.

Defrost Interval

Defrost Interval in Hours: 0, 1, 1.5, 2, 2.5, 3, 4, 5 & 6
AUT: Microprocessor optimized automatic defrost according to type of cargo.

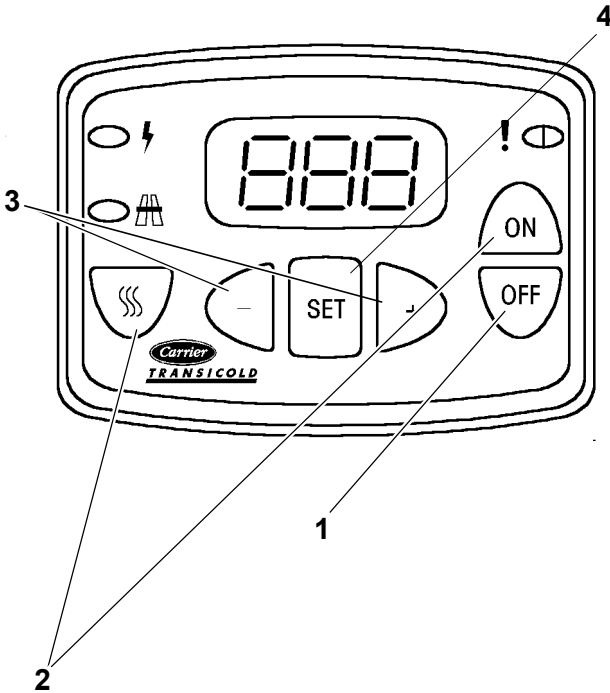

1. Press the OFF key.
2. Press Defrost and ON key to display the previously selected defrost interval.
3. Press -- (minus) or + (plus) key to select defrost interval.
4. Press the SET key to validate modified value.

Minimum Setpoint, Out-of-Range, and Continuous Airflow

Minimum Setpoint Settings: -20°F (-28.9°C), -4°F (-20°C), or 32°F (0°C)

Out-of-Range Settings: 1.8, 3.6 or 5.4°F (1, 2 or 3°C)

Continuous Airflow Settings: ON or OFF

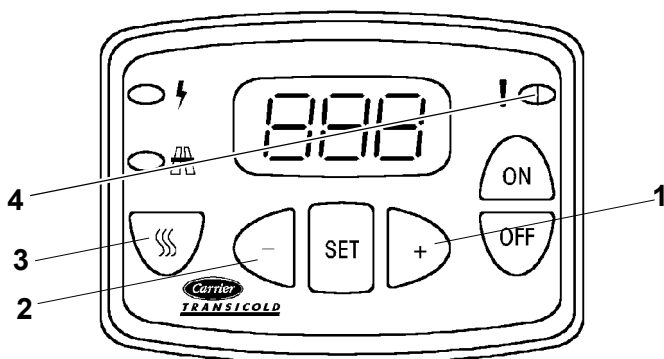

1. Turn unit on and press + (plus) key.
2. Press – (minus) key.
3. Press Defrost key.
4. Check that the ! light flashes green.
5. The operator can select a minimum set point. The selections are -20°F (-28.9°C), -4°F (-20°C), or 32°F (0°C). Press + or – key to change setting.
6. Press the SET key to save setting. Out-of-range setting will appear next.
7. Press the + key to increase out-of-range setting. Press the – key to decrease out-of-range setting.
8. Press the SET key to save out-of-range setting.
9. Check that the display shows ON or OFF. ON indicates That the evaporator fan continues to run when the setpoint is reached for constant air flow. OFF indicates the evaporator fan stops when box temperature is within setpoint range.
10. Press the + or – key to change airflow option. Press the SET key to save fan mode setting.

Stopping the Unit

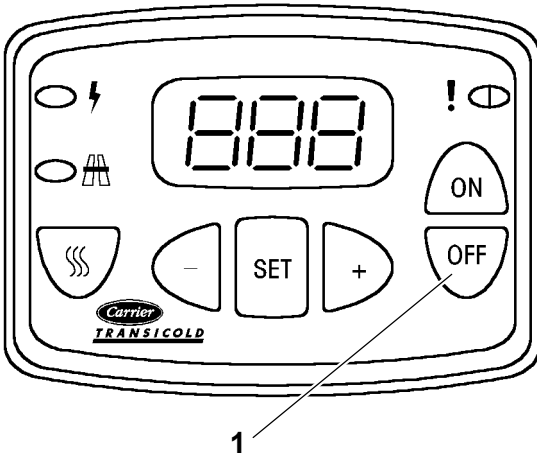

Press the OFF key.

Product Loading

Before Loading

- Pre-cool the body. This will remove much of the heat from the inside of the body and give the product better protection when it is loaded.
- Place the unit in a defrost cycle immediately before loading. This will remove moisture accumulated on the evaporator coil.

During Loading

- Turn the unit off!
- Check product temperature during loading.
- Ensure that the air return and supply opening remain unobstructed.
- Leave approximately 4 to 5 inches between the load and the front wall for air return to the unit.
- Leave at least 10 to 12 inches between the top of the load and the ceiling to ensure there is nothing to prevent airflow to the rear of the body.
- Load product on pallets to provide free air return to unit and improve product protection.

Proper air circulation in the truck body (air that can move around and through the load) is a critical element in maintaining product quality during transport. If air cannot circulate completely around the load, hot spots or top-freeze can occur.

The use of pallets is highly recommended. When loaded, air can flow freely through the pallets to return to the evaporator, helping to protect the product from heat passing through the floor of the truck. When using pallets, it is important to refrain from stacking extra boxes on the floor at the rear of the truck as this will cut off the airflow.

Product stacking is another important factor in protecting the product. Products that generate heat – fruits and vegetables, for example – should be stacked so the air can flow through the product to remove the heat. This is called “air stacking” the product. Products that do not create heat – meats and frozen products - should be stacked tightly in the center of the trailer.

All products should be kept away from the side walls of the body, to allow air flow between the body and the load; this prevents heat filtering through the walls from affecting the product.

It is important to check the temperature of the product being loaded to ensure that it is at the correct temperature for transport. The refrigeration unit is designed to maintain the temperature of the product at the temperature at which it was loaded; it was not designed to cool warm product.

Recommended Transport Temperatures

Below are some general recommendations on product transport temperatures and operating modes for the unit. These are included for reference only and should not be considered preemptive of the set point required by the shipper or receiver.

More detailed information can be obtained from your Carrier Transicold dealer.

Product	Setpoint Range	
	°F	°C
Bananas	56 to 58	13 to 14
Fresh fruits and vegetables	33 to 38	0.5 to 3
Fresh meats and seafood	28 to 32	-2 to 0
Dairy Products	33 to 38	0.5 to 3
Ice*	15 to 20	-10 to -7
Frozen fruits and vegetables*	-10 to 0	-23 to -18
Frozen meats and seafood*	-10 to 0	-23 to -18
Ice Cream*	-20 to -15	-29 to -26

During delivery cycles that include frequent stops and door openings, it is recommended that the unit be turned off during the time the body doors are open to help conserve the product temperature.

* Variations may be necessary for very high or very low ambient temperatures.

Problems and Alarms

Everything possible has been done to ensure that your unit is the most reliable, trouble-free equipment available today. If, however you run into problems the following section may be of assistance.

If you do not find the trouble that you have experienced listed, please call your Carrier Transicold dealer for assistance.

General Problems	
Unit does not power up	<ul style="list-style-type: none">• Check battery condition• Check battery connections• Check all fuses
Unit does not start	Check all fuses
Unit does not run	Check all fuses
Unit shut down	Check alarm codes
Unit not cooling properly	<ul style="list-style-type: none">• Check minimum setpointÁ setting (see page 1Í)• Defrost unit• Check evaporator for airflow restrictions.• Check condenser for airflow restriction• Check body for damage or air leaks• Check product is loaded properly• Check refrigerant charge

Alarm Display

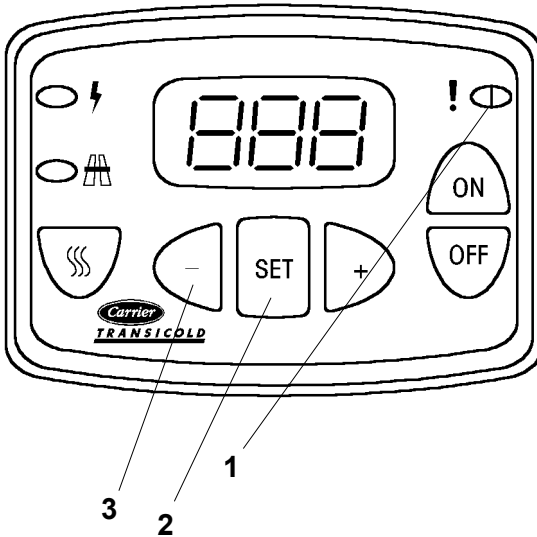

1. When an alarm is activated, the ! light flashes red.

The ! light flashes green when the unit is operating correctly.

2. Press the SET key for five seconds to display alarms.
3. Press + (plus) or - (minus) key to view additional alarms.
4. Press SET key to return to box temperature display.

Alarm List

Alarm	Alarm Description
A00	No Malfunction
A01/A02	High or Low Pressure Switch
A04	Road Compressor Clutch
A06	Condenser Fan Motor (high amp draw)
A07	Evaporator Fan Motor (high amp draw)
A09	Hot Gas Valve (HGS1) (high amp draw)
A10	Quench Valve (BPV) (high amps draw)
A11	Condenser Pressure Control Valve (HGS2)
A12	High Temperature Alarm
A13	Low Temperature Alarm
A14	Defrost Cycle Is greater than 45 minutes
A15	Setpoint out of range
2EP	Functional parameters have not been set or have been lost. Press and hold the SET key to clear the alarm.
EE	Return Air Sensor
bAt	Low Battery Voltage
Err	Programming error by user.
---	Setpoint lower than maximum setpoint but in the range

Alarm Reset

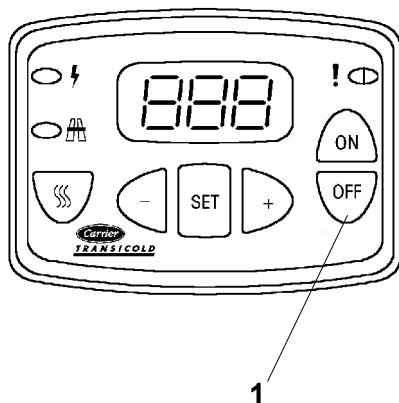

Press the OFF key to clear alarm list. Unit can now be restarted if no active alarm condition remains.

Fuses

To access the fuses in the electrical box, remove the upper cowling from unit, then open the control box (fastened by three screws).

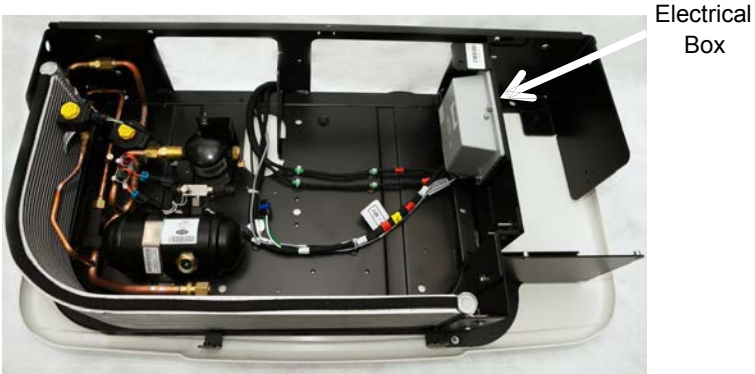

35X Fuses			
Fuse	Purpose	12V	Location
Fin	Ignition	1A	Cab
FR1	Road Supply Fuse	50A	Engine
FEFM	Evaporator Fan Motor 1 &	20A	Electrical Box
FCFM	Condenser Fan Motor	30A	Electrical Box
FMP	Microprocessor Board	10A	Electrical Box
20X Fuses			
Fuse	Purpose	12V	Location
FI	Ignition	1A	Engine Compartment
F1	Main Road Fuse	40A	Vehicle Battery
FUS	Road Supply Fuse	25A	Condenser

To access the fuses in the control box, remove the upper cowling from unit, then open the control box (fastened by three screws).

Unit Maintenance

WARNING

Before working on unit, check that:

- The unit (cab command) is OFF.
- It is impossible for unit to automatically start-up during maintenance.

Refrigerant Charge: R-404a

Refrigerant Charge	
Unit	Charge
20X	3.1 lbs (1.4 kg)
35X	3.3 lbs (1.5 kg)

Oil Charge: Carrier POE #46-0002-02

Compressor Oil	
Unit	Oil Charge
20X	4 oz. (120 ml)
35X	4 oz. (120 ml)

For the most reliable operation and for maximum life, your unit requires regular maintenance. Maintenance should be performed on the following schedule:

Miles X 1000	3	18	36	54	72	90	108	126
Service A	X	X	X	X	X	X	X	X
Service B		X	X	X	X	X	X	X
Service C			X		X		X	
Service D					X			

Service Schedule

Service A	<ol style="list-style-type: none"> 1. Check the tension of the alternator/compressor belt. 2. Check that the vehicle engine runs correctly at low speed and that the compressor mounting kit is correctly tightened and that belt tension is correct. 3. Check the tightness of bolts and screws and that the unit is correctly fastened onto the box.
Service B	<ol style="list-style-type: none"> 1. Clean condenser and evaporator coils. 2. Replace road compressor belt. 3. Check and, if required, replace filter drier. 4. Check operation of Cab Command Two Controller. 5. Check the defrost: <ul style="list-style-type: none"> • Cut-in • Fan shut-down • Cut-out • Defrost water drain(s)
Service C	<ol style="list-style-type: none"> 1. Check the operation of the evaporator and condenser fans. 2. Change condenser motor brushes. The evaporator is equipped with brushless fan motors, brush maintenance is not required. 3. Change compressor oil Use polyol ester oil (POE) approved by Carrier Transicold.
Service D	Change the removable fuses and capacitors (if any) in the control box.

Emergency Road Service

At Carrier Transicold we are working hard to give you complete service when and where you need it. That means a worldwide network of dealers that offer 24-hour emergency service. These service centers are manned by factory trained service personnel and backed by extensive parts inventories that will assure you of prompt repair.

Should you experience a problem with your unit during transit, follow your company's emergency procedure or contact the nearest Carrier Transicold service center. Consult the Shortstop Service Centers directory, or visit www.trucktrailer.carrier.com and click on "Dealer Locator" to locate the service center nearest you. The Shortstop directory may be obtained from your Carrier Transicold dealer.

You can also download the Carrier Transicold North America Truck/Trailer Dealer Locator App to your smart phone. The Dealer Locator App provides:

- Location information for every Carrier Transicold dealer in North America
- The nearest dealer from your present location
- Dealer look-up capability
- Dealer services (Trailer, Truck, APU, Mobile Support, etc.)
- Addresses
- Maps to easily find dealers
- Directions and navigation to the dealerships
- Phone number and 24-hour emergency hot-lines where available
- Auto dialing
- Hours of operation
- Link to dealer website
- Ability to add dealers to Contacts

To download the Carrier Transicold North America Truck/Trailer Dealer Locator App, scan this QR code, or go directly to your App store.

If you are unable to reach a service center, call our 24-hour Action Line: (800) 448-1661

We will do everything we can to get your problem taken care of by an authorized CTD dealer and get you back on the road.



Index

A

Alarm Display, 17

Alarm List, 18

C

Continuous Airflow, 11

D

Defrost Interval, 10

E

Emergency Road Service, 23

F

Fuses, 20

K

Keypad and Display, 5

M

Manual Defrost, 9

Minimum Setpoint, 11

O

Operating principle, 6

Out-of-Range, 11

P

Problems & Alarms, 16

Product Loading, 13

R

Recommended
Transport
Temperatures, 15

Refrigerants, 2

S

Safety, 2 Setpoint, 8,11

Starting the Unit, 7

Stopping the Unit, 12

Keypad and Display, 5

T

Temperature Setpoint, 8

U

Unit Identification, 3

Unit Maintenance, 21

Unit Operation, 6

CALIFORNIA Proposition 65 Warning

Diesel engine exhaust and some of its constituents are known to the State of California to cause cancer, birth defects, and other reproductive harm.

Specifications are subject to change without notice.

Warranty: Product warranty and limitations are outlined in Form 62-11019.

This warranty applicable only in North America. Consult your Carrier Transcold representative for warranty coverage elsewhere.

North America

Carrier Transcold
700 Olympic Drive
Athens, GA 30601 USA

Central America and Mexico

Carrier Transcold
Ejercito Nacional 253-A Piso 5
Colonia Anahuac
11320 Mexico D.F.

©2018 Carrier Corporation. Printed in USA 4/18

Carrier and Transcold are registered trademarks of Carrier Corporation



www.trucktrailer.carrier.com